



FIBERPOOL

FÁBRICA DE PILETAS

CATÁLOGO 2024-2025



PAREDES INTERNAS
Diseñadas para un
limpieza simple evitando
el mantenimiento

BORDE Y PESTAÑA
FACILITAN LA INSTALACIÓN
Y EVITAN POTENCIALES
FILTRACIONES

MATERIALES REFORZADOS
POLIURETANO EXPANDIDO
EVITANDO MARCAS INTERNA
COMO EN EL CASO DE LA MADERA
O EL CARTÓN

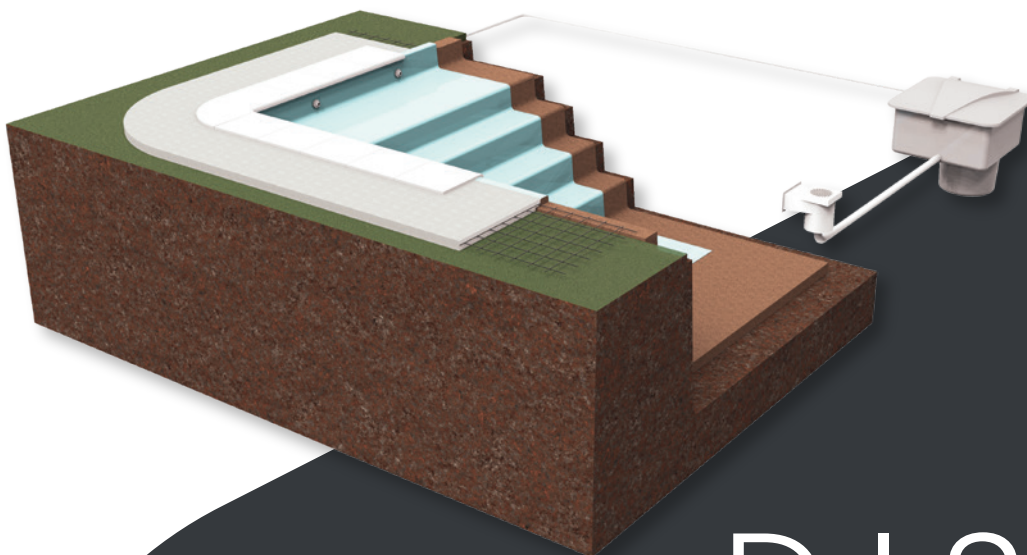

**DISEÑO
INTELIGENTE**

MINI PISCINA

FLOW

LARGO Y ANCHO
3.7 mts. x 2 mts.

ESCALÓN INGRESO
0.35 MTS.

PROFUNDIDAD
0.7 mts.

ASIENTO
6 MOLDURAS RETORNOS
2 MOLDURAS LATERALES
(LUZ O SUCCIÓN)

VOLÚMEN
2100 Lts.

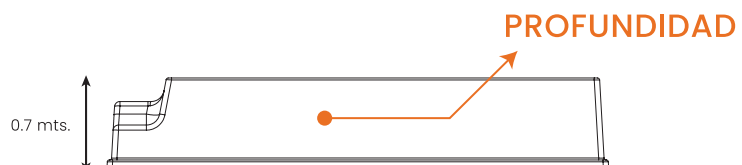
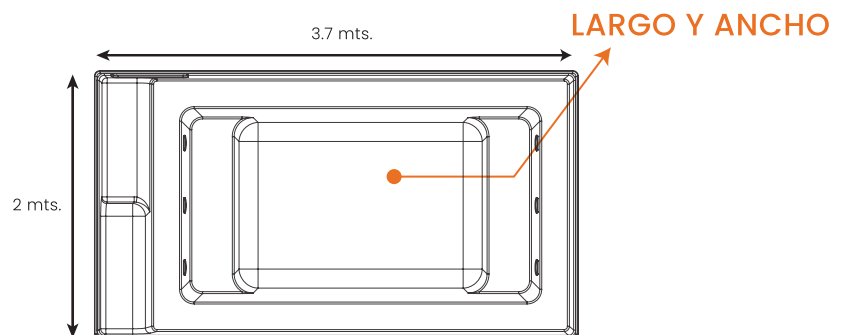
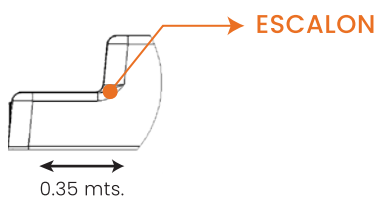
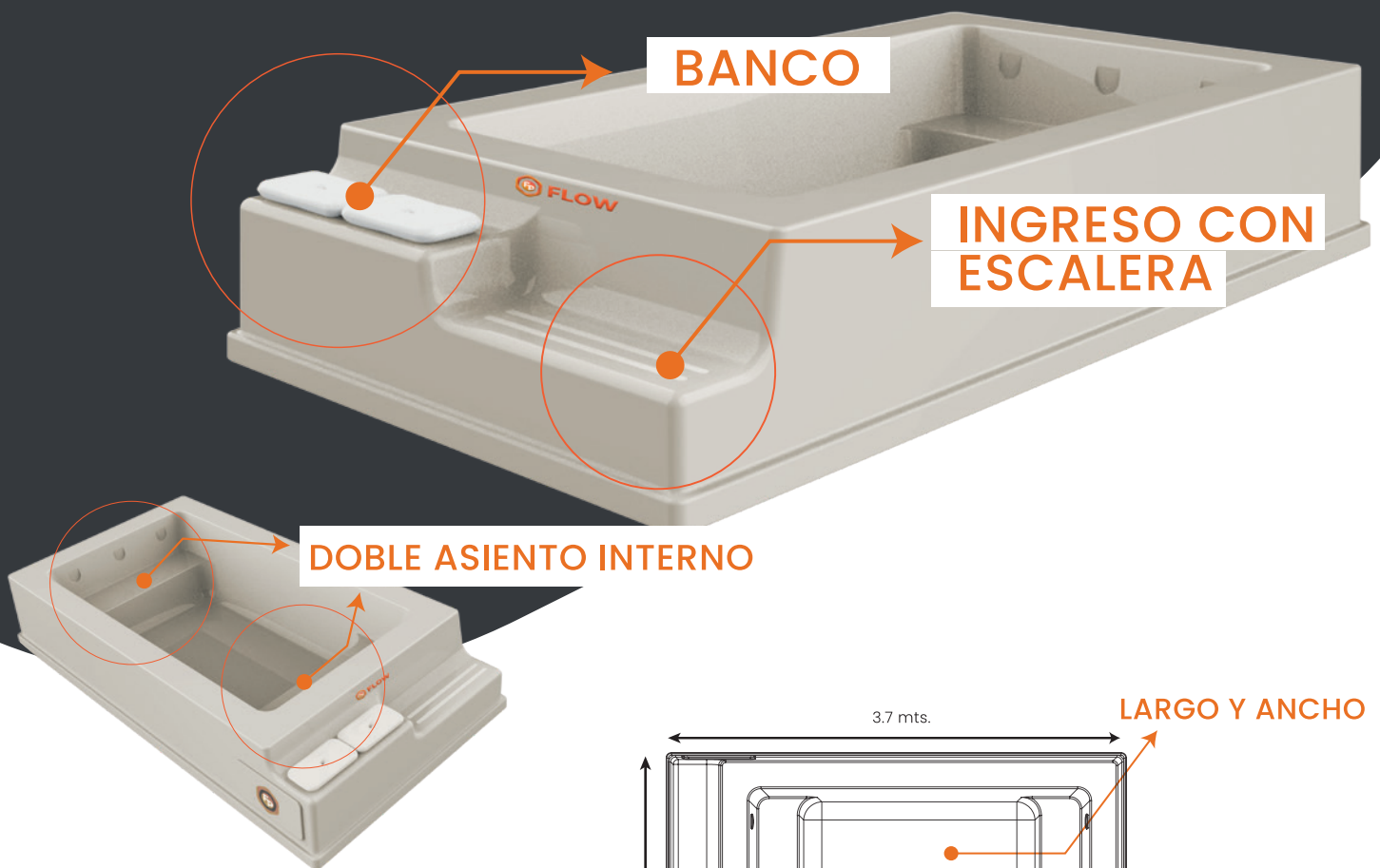

LÍNEA RECTA

GRAN ENCUENTRO

ENCUENTRO

FAMILIAR

PRIVADA



LARGO Y ANCHO
4 mts. x 2,5 mts.
VOLUMEN TOTAL (AL RAS)
8494 LTS
PROFUNDIDAD
1,4 mts.
MOLDURA SKIMMER
2 MOLDURAS RETORNOS

LARGO Y ANCHO
5 mts. x 3,17 mts.
VOLUMEN TOTAL (AL RAS)
14690 LTS
PROFUNDIDAD
1,4 mts.
MOLDURA SKIMMER
3 MOLDURAS RETORNOS

LARGO Y ANCHO
6,57 mts. x 3,17 mts.
VOLUMEN TOTAL (AL RAS)
20502 LTS
PROFUNDIDAD
1,4 mts.
MOLDURA SKIMMER
3 MOLDURAS RETORNOS

LARGO Y ANCHO
7,57 mts. x 3,17 mts.
VOLUMEN TOTAL (AL RAS)
27400 LTS
PROFUNDIDAD
1,4 mts.
MOLDURA SKIMMER
3 MOLDURAS RETORNOS

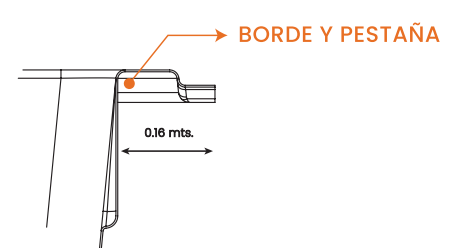
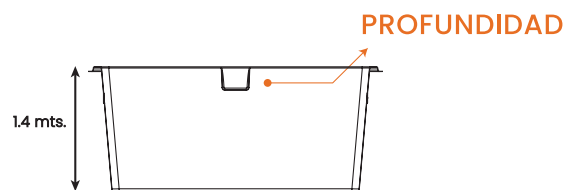
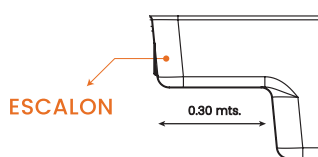

LÍNEA SOLARIUM

SH GRAN ENCUENTRO

SH ENCUENTRO

SH FAMILIAR

SH PRIVADA



LARGO Y ANCHO
4,55 mts. x 2,5 mts.
SOLARIUM HUMEDO
0,90 mts.
VOLUMEN TOTAL (AL RAS)
8650 LTS
PROFUNDIDAD
1,4 mts.
MOLDURA SKIMMER
2 MOLDURAS RETORNOS

LARGO Y ANCHO
5,55 mts. x 3,17 mts.
SOLARIUM HUMEDO
1,10 mts.
VOLUMEN TOTAL (AL RAS)
14850 LTS
PROFUNDIDAD
1,4 mts.
MOLDURA SKIMMER
3 MOLDURAS RETORNOS

LARGO Y ANCHO
6,57 mts. x 3,17 mts.
SOLARIUM HUMEDO
1,25 mts.
VOLUMEN TOTAL (AL RAS)
17700 LTS
PROFUNDIDAD
1,4 mts.
MOLDURA SKIMMER
3 MOLDURAS RETORNOS

LARGO Y ANCHO
7,57 mts. x 3,17 mts.
SOLARIUM HUMEDO
1,25 mts.
VOLUMEN TOTAL (AL RAS)
27400 LTS
PROFUNDIDAD
1,4 mts.
MOLDURA SKIMMER
3 MOLDURAS RETORNOS

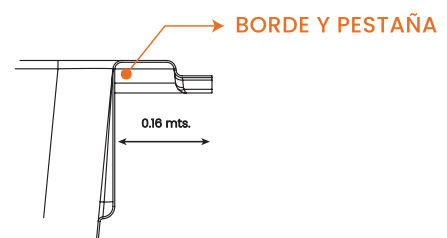
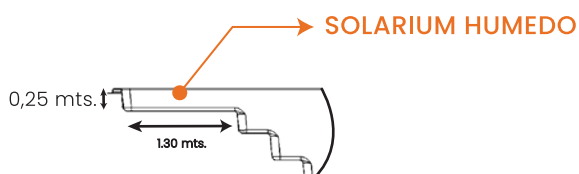
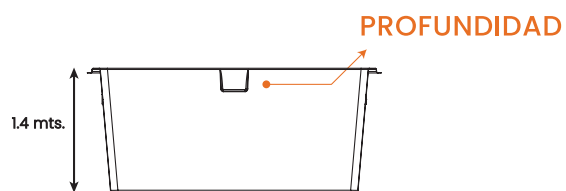
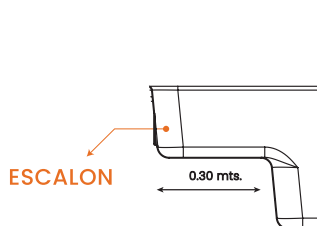

LOSETAS ATÉRMICAS

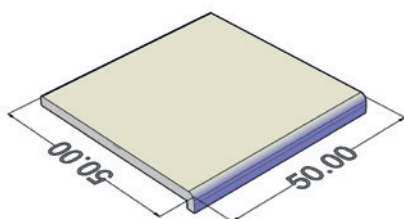

BORDE L 50 cm x 50 cm

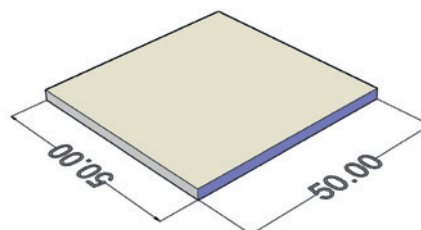

**SOLARIUM
ATÉRMICO** 50 cm x 50 cm

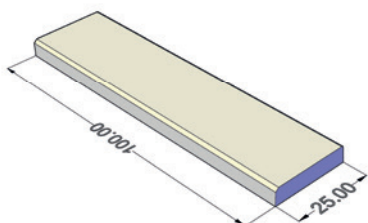

**BORDE
RECTO** 100 cm x 25 cm

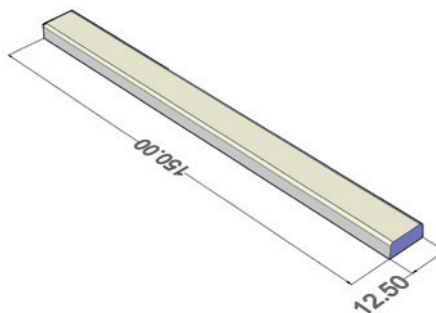

**LISTON
DECK** 150 cm x 12.5 cm

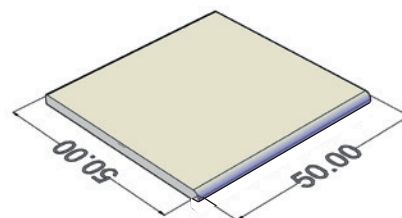

**BORDE
ORIENTAL** 50 cm x 50 cm



CASILLA CHICA

30000 Litros
1,15 m. x 0,83 m.
Altura 0,95 m.
5 llaves
de paso.



CASILLA GRANDE

50000 Litros
1,15 m. x 1,05 m.
Altura 0,95 m.
6 llaves
de paso.



CASILLAS



+54 9 3518 53 8000

Parque industrial Villa Adelina
Agustín Paolucci 171
Córdoba, Argentina



con el apoyo

